

30mm Height Standard Waste Shower Trays





(Requires fitting kit - to be purchased separately)

Parts Supplied

Description		Qty
Shower Tray		1

Parts Required (Not supplied)

Description		Qty
Shower Drain Base		1
Shower Drain Socket		1
Shower Drain Reducer		1
Shower Drain Internal Bowl		1
Shower Drain Internal Dome		1
Shower Drain Top		1
Disposable Tiling Aid		1
Shower Drain Finishing Grate		1
Lubricant		1

Description		Qty
Fix-KST Adhesive Bag		*
Wood Floor Primer (250ml)		*
Fix-MD Adhesive Tube (310ml)		*
Waterproofing Tape		*
Pro-SEAL Pre-MIX		*
Waterproofing Internal Corner		*

***Quantities may vary according to installation.**

Additional Parts required (depending on Installation type)

- 10mm Marine Plywood (size depends on room)
- Cement Based Flexible Tile Adhesive
- 90mm Substrate Element
- Timber Battens (approx 20mmx50mm)
- 18mm Marine Plywood (approx size of shower tray required, i.e., 1200x900mm)
- Waterproof Matting

Tools required (not supplied)

- Tools required (not supplied)
- Paint Brush (Wood Floors Only)
- Notched Adhesive Trowel
- Tape Measure
- Pencil
- Straight Edge
- Hard Point Saw
- Junior Hacksaw
- Protective Gloves
- Eye Protection
- Breathing Protection
- Bucket
- Level
- Solvent Weld Adhesive
- Sealant Gun
- Measuring Jug

Before You Start

THIS PRODUCT CAN BE INSTALLED IN THE FOLLOWING THREE WAYS

A

30mm high tiled shower base installed onto an existing timber floor.

Surface Installation -
30mm height
(Timber Floor)

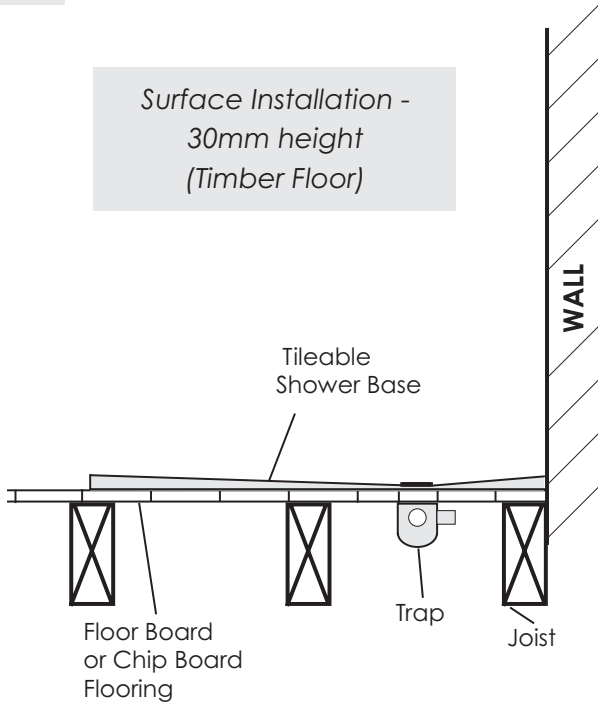

B

Level access wetroom tiled shower tray built into existing flooring.

Level Access Installation
(Timber Floor)

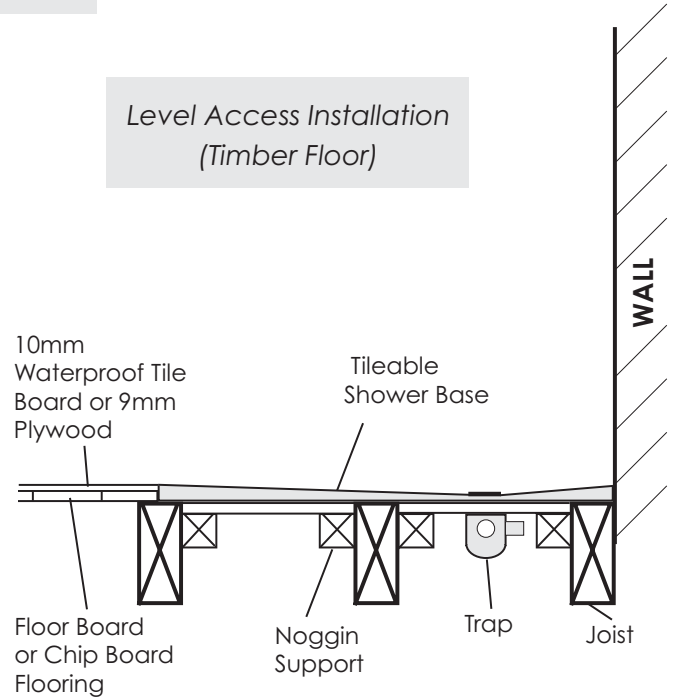

C

Installation using a 90mm substrate element (to be purchased separately)

Raised Surface Installation
(Timber or concrete Floor)

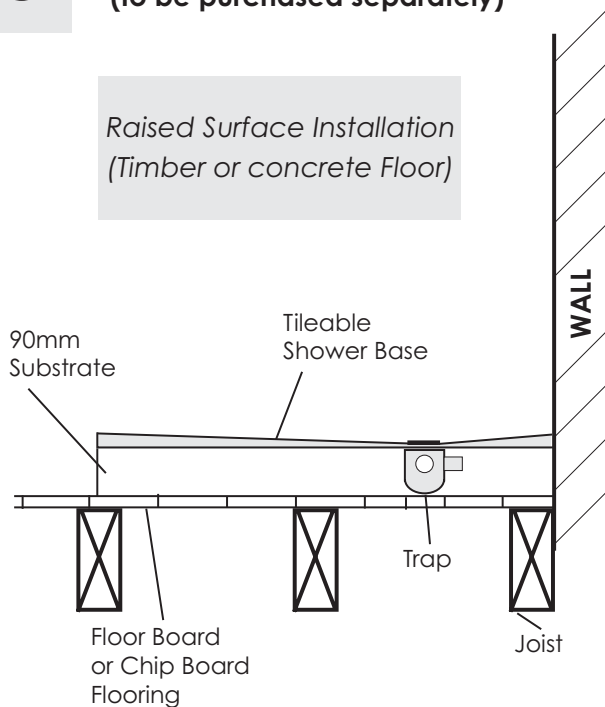

Please decide how you are installing your tray and follow either section A, page 4, section B, page 9 or section C, page 16 in the following instructions

Important Information

PLEASE READ THESE INSTRUCTIONS THOROUGHLY BEFORE STARTING INSTALLATION.

If your product has slightly damaged edges, there is no need to return the product as these can easily be repaired and most minor damage will naturally be covered during installation.

Should you need to patch a repair that won't be naturally covered you should do so in the same way as you would seal a joint with Waterproofing Tape and Pro-DRY Tape Sealer.

DO NOT PLACE STEP LADDERS OR HEAVY ITEMS ONTO THE SHOWER TRAY OR OTHER PRODUCTS, PRIOR TO TILING, AS THIS COULD PUNCH A HOLE THROUGH THE SURFACE.

DO NOT CLIP THE WASTE INTO POSITION WITHIN THE TRAY UNTIL INSTRUCTED TO DO SO IN THE INSTRUCTIONS THAT FOLLOW; THE WASTE CLIPS INTO THE TRAY SECURELY AND IS NOT DESIGNED TO BE REMOVED, THEREFORE THIS MAY CAUSE DAMAGE TO THE TRAY LUGS AND/ OR WASTE IF THIS WARNING IS IGNORED. WE CANNOT BE HELD LIABLE FOR ISSUES ARISING DUE TO DAMAGE CAUSED IN THIS WAY.

When you are ready to start, make sure that you have the right tools to hand and that the installation area is clean and dry. When drilling or fixing into walls or floors it is essential that you check for pipes and wires before commencing.

Site Preparation

All floor types need to be clean, dry and dust free.

All floor types need to be as flat and level as possible.

Prior to installation you will need to have access to a wastepipe in the correct position. Please ensure that the wastepipe is accessible and any alterations to the floor are completed prior to installation.

If you are running your pipe work below the floor, the waste pipe must run in the same direction as your floor joists so please check your joists before starting installation.

When you are ready to start, make sure that you have the right tools to hand and that the installation area is clean and dry.

Section A

Installation Type **A**

Surface installation (onto timber floor)

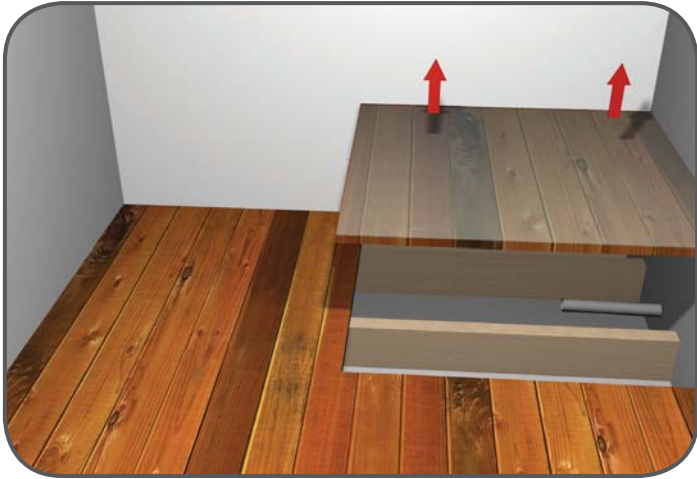

1. Remove flooring as necessary to carry out works to the wastepipe. Please note that if there is a joist in the way of the Shower Tray you will need to consult a professional joiner or structural engineer for advice.

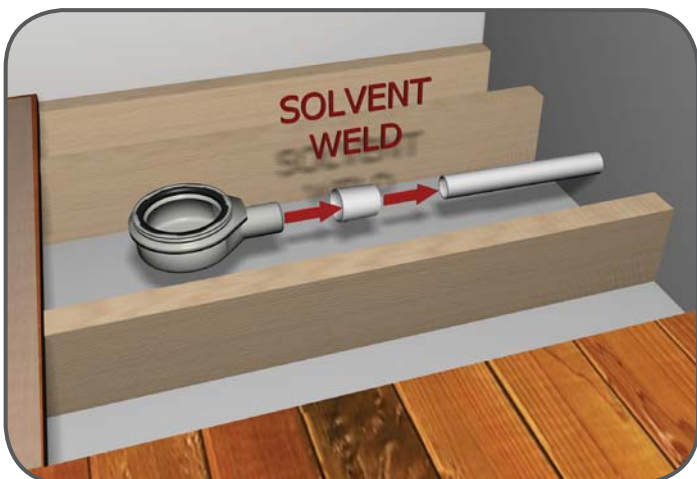

2. For water to drain away properly, the wastepipe must have a fall of at least 3cm per metre. The wastepipe must be properly supported to hold its own weight and that of the Shower Drain. Connect the Shower Drain to your wastepipe using a 2" solvent weld connector (also supplied is a shower drain reducer if required). Once the solvent weld has set; pour water down the drain to check that the waste is not blocked and that there are no leaks. Replace the flooring ensuring that an adequate hole has been cut to allow for the Shower Drain to be exposed through the floor.

Please note: The hole size should be no bigger than 180 x 180mm.
Smear some lubricant around the black rubber seal on the Shower Drain.



3. **Note:** Wear protective gloves, eye and breathing protection. Mix the 5kg bag of Fix-KST adhesive with approximately 1 Litre of water in a clean bucket which will give the adhesive a stiff consistency. Spread the Fix-KST adhesive onto the floor of the shower position and drag a 6mm notched adhesive trowel across the surface. The notched adhesive trowel will make a ribbed pattern which will leave just the right amount of adhesive on the floor.

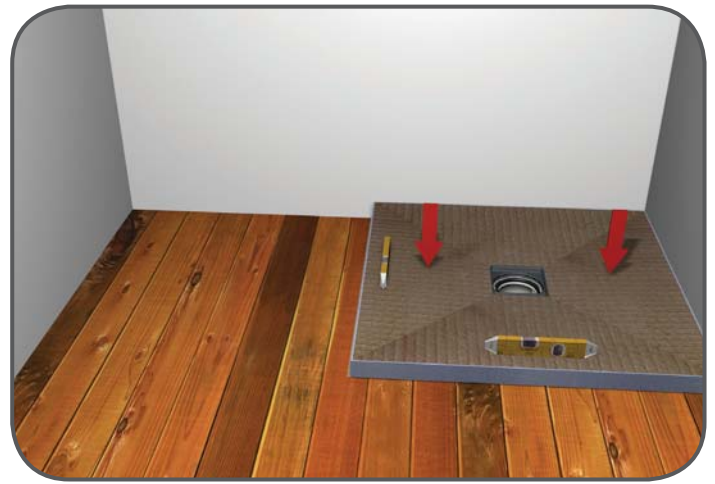

4. Place the Shower Tray into position and bed down onto the adhesive cement. Check that the shower tray is level in both directions using a suitable level.



5. Put your fingers through the drain hole in the Shower Tray. Push down on the Shower Tray and pull the Shower Drain upwards until it clicks into place into the drain hole in the Shower Tray.

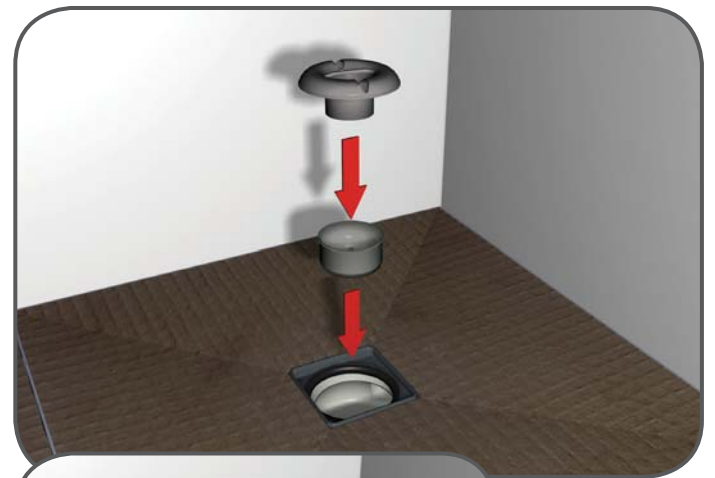

6. Ease the Shower Drain Internal Bowl into the Shower Drain. Ease the Shower Drain Internal Dome into the Shower Drain. When you have finished you can remove the protective gloves and eye and breathing protection.



7. You will need to tape all joints where the tray meets an adjoining wall/s. Cut lengths from the roll of Waterproofing Tape and set aside for the moment.

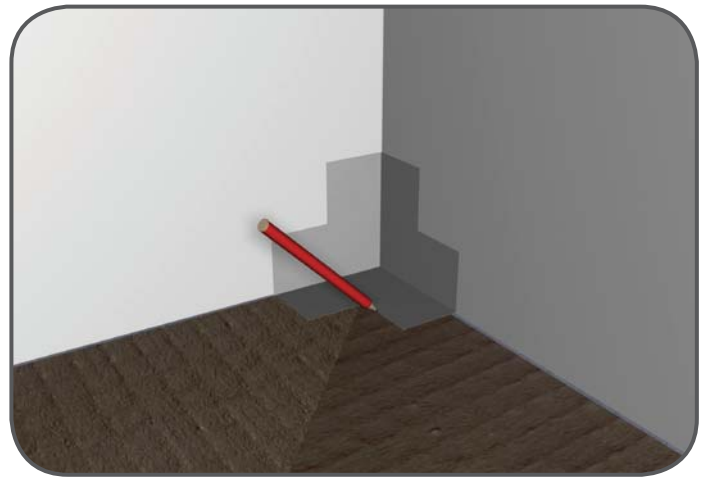

8. Temporarily place the Waterproofing Internal Corners into position and mark around them with a pencil. Once you have marked they can be set aside for the moment. This is to show where you need to apply the Pro-SEAL tape sealer.

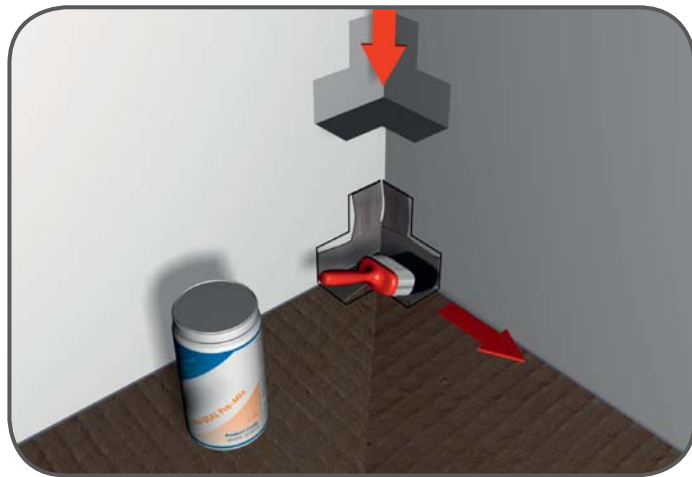

9. **Note:** Wear protective gloves, eye and breathing protection. Apply a thin layer of Pro-SEAL tape sealer to the internal corners of the shower area, slightly bigger than the pencil line marked in step 8.

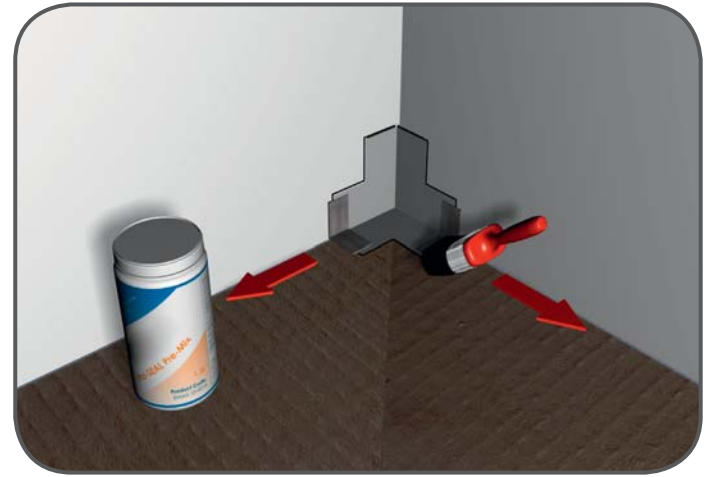

10. Place the Waterproofing Internal Corners into the internal corners of the shower area and push firmly into the Pro-SEAL tape sealer. Apply a further thin layer of Pro-SEAL tape sealer over the edges of the waterproofing internal corners.



11. Where the shower area meets the wall apply a thin layer of Pro-SEAL tape sealer to the shower area and the adjoining wall approximately 60mm wide on both.



12. Place the strips of Waterproofing Tape previously cut in step 7 along the edges of the shower area, folding half up the wall and half on the shower area as you go. Press firmly into the Pro-SEAL tape sealer and the tape should also overlap the Waterproofing Internal Corners. When you have finished you can remove the protective gloves and eye and breathing protection.

Important Tiling Advice

IT IS ESSENTIAL THAT YOU DO NOT USE A READY MIXED TILE ADHESIVE. FLEXIBLE CEMENT BASED POWDERED ADHESIVE MUST BE USED WITH SHOWER TRAYS.

The Shower Tray has slopes towards the drain pre-formed into the tray and these must be maintained. If you use tiles that are larger than 100mm it is necessary to cut the tiles along the same lines as are pre-formed into the Shower Tray to maintain the slope. For best results and ease of installation we would recommend mosaics or tiles of 50mm to 100mm.

These Shower Trays are perfect for use with electrical under tile heating due to their excellent thermal properties. It is however essential that you check with the manufacturer that their product is entirely suitable for the area that you intend to install it in. If you are installing under tile heating it is essential that you consider any areas that will need products fixed to the floor for example shower screens. Avoid installing under tile heating directly below any fixing point to avoid the risk of screwing through the heating.

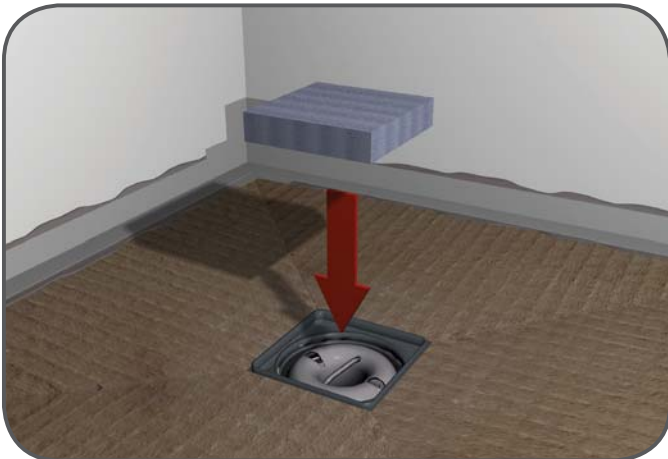

13. Place the Disposable Tiling Aid into the shower drain hole on the Shower Tray. The Tiling Aid provides the edge that needs to be tiled up to whilst protecting the Shower Drain from debris.

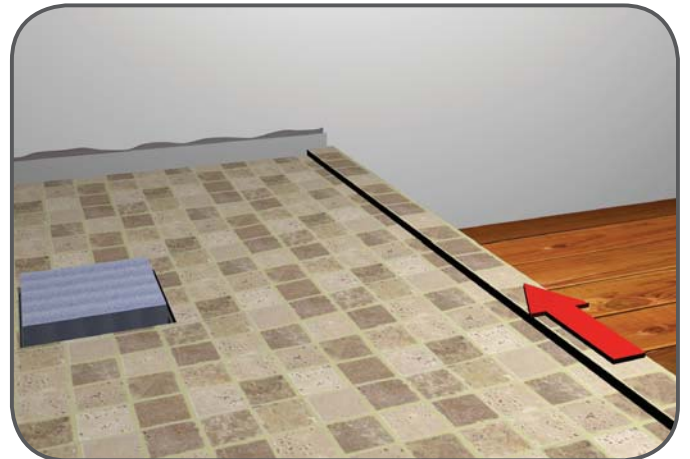

14. (Optional) After tiling the base of the shower area, we recommend that you add a further narrow border of tiles approximately 30mm to 40mm wide, along the top of the outside edge to act as a water retainer, stopping water running out of the shower area. The tiling aid can now be removed and disposed of.

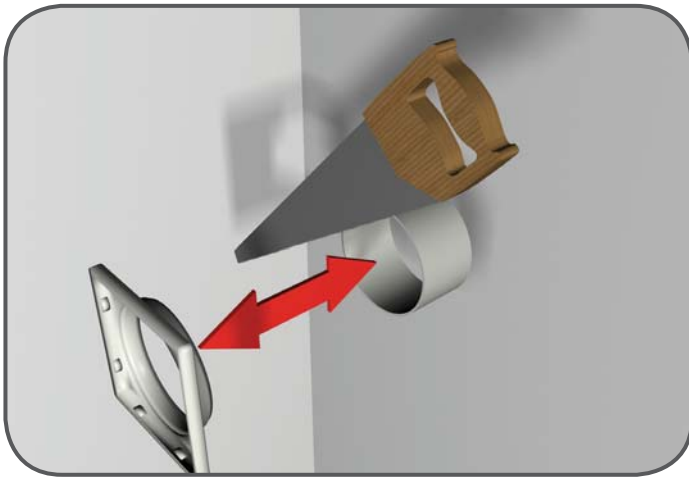

15. After tiling the Shower Tray, the Shower Drain Top can be fitted. Gently place the Shower Drain Top into the Shower Tray. Measure from the top of the finished tile to the top of the Shower Drain Top. From the opposite end/ bottom of the Shower Drain Top mark the same distance as previously measured. Using a hand saw, cut the excess from the bottom of the Shower Drain Top. Depending on your cutting skill, it may be necessary to file or sandpaper the cut edge to make it completely flat.

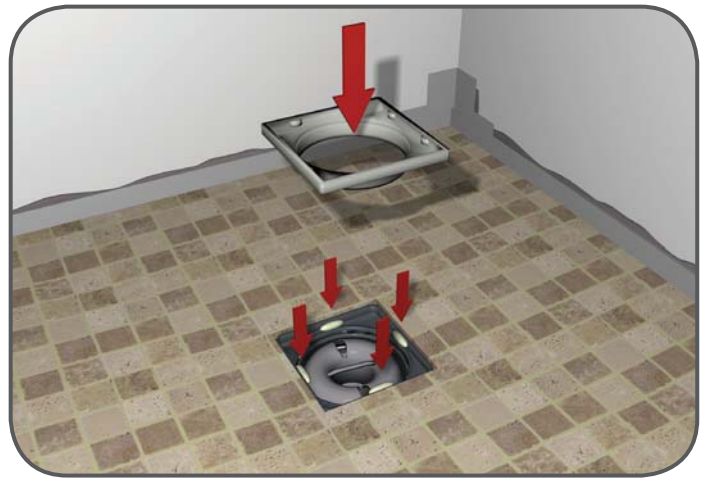

16. Place a small blob of tile adhesive in the middle of all four sides of the Shower Drain Hole in the Shower Tray. Gently ease the Shower Drain Top into position in the Shower Tray. Leave to set for approximately 3 to 5 hours. Fill the gap between the edges of the Shower Drain Top and the start of the tiles with the same grout used during tiling. Place the Shower Drain Finishing Grate into position. Leave to dry for at least 24 hours before using the shower.

Section B

Installation Type **B**

Level Access installation (onto timber floor)

Step 1

Mark the shower tray position onto the floor, the shower tray is 1200mm x 900mm. Measure the position of the waste hole in the shower tray. Carefully remove the shower tray and store somewhere safe.

Note: we recommend that the shower tray should wherever possible be butted up against the corner of the room.



Step 2

From the nails or screws holding the existing flooring down, establish where the joists are. Where the edge of the shower tray runs across the joists, the floor cut line will be as marked in step 1. Where the edge of the shower tray runs in the same direction as the joists, mark the centre line of the first joist outside the shower area as you will need to remove the floor up to this line.



Step 3

Before proceeding, check thoroughly for pipes and wires under the floor.

Set the circular saw blade to a depth of 18mm, it may be necessary to increase the depth slightly if 18mm does not go right through the floor. As a safety precaution, we would recommend that the circular saw is plugged into an RCD protected socket. Using the circular saw cut along the lines that you have marked and remove the flooring and all nails or screws.

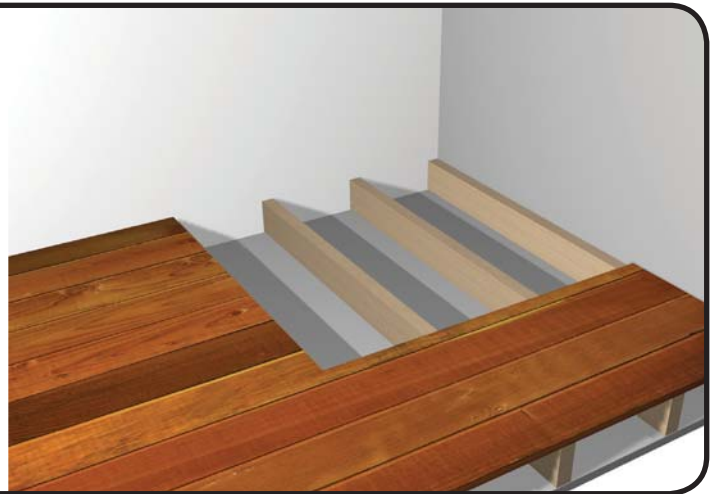

Step 4

Make sure that the remaining floor boards or sheets in the rest of the room are fully secured down and as level and flat as possible.

Step 5

For water to drain away properly, the wastepipe must have a fall of at least 3cm per metre. If you are using 40mm diameter pipe it is essential that the shower has its own separate wastepipe with as direct run to the soil stack as is possible. Using the waste hole position measurement obtained in step 2, make any necessary alterations to your wastepipe. The wastepipe must be properly supported to hold its own weight and that of the shower drain base.

40mm Wastepipe Only

Solvent weld the shower drain reducer into the shower drain socket

40 & 50mm Wastepipe

Smear some lubricant around the black rubber seal on the shower drain base

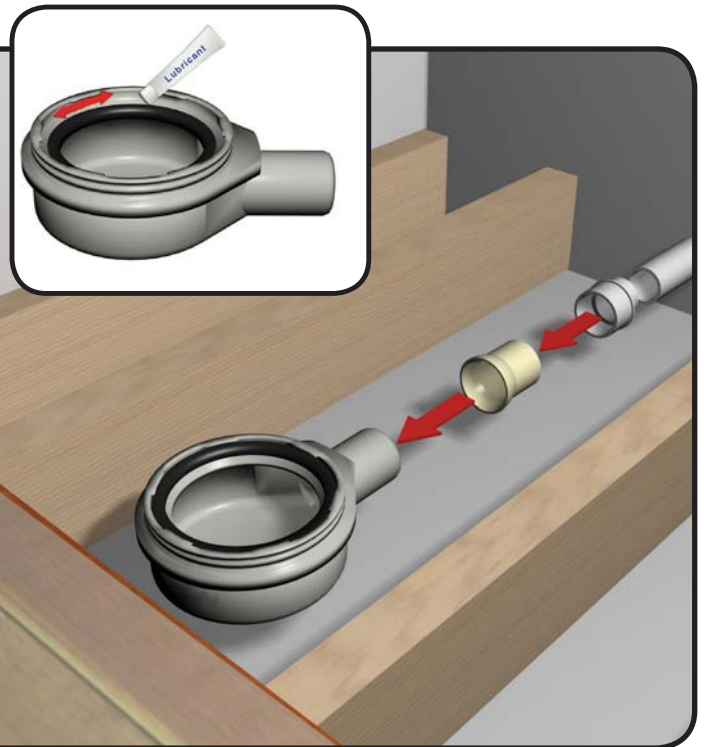

Step 6

All exposed joists will now need a batten running along the inside of the joist to accommodate the new plywood low level floor. Measure the length of the exposed joist taking into account any obstructions. Cut some timber batten (approx 20mm x 50mm) to length and screw at approximately 150mm intervals to the inside of all joists 18mm below the top of the joists.

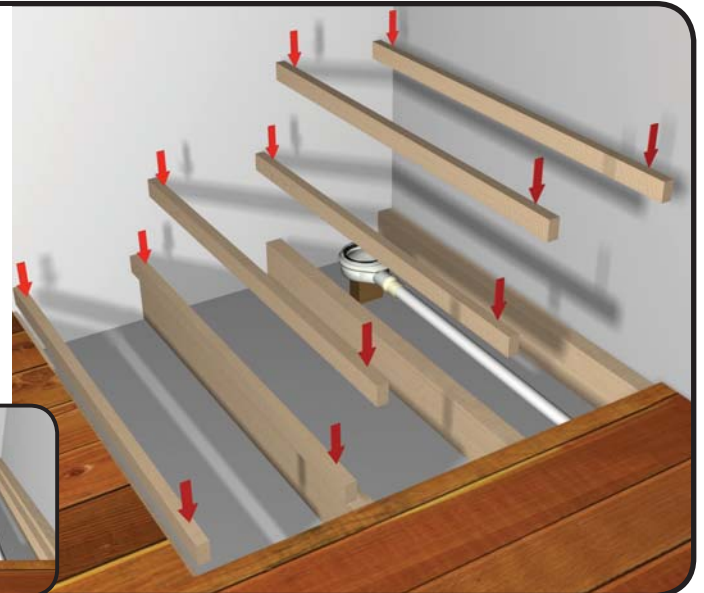
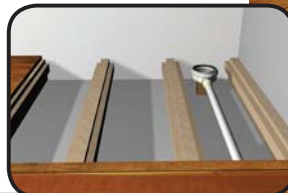

Step 7

Cut some 18mm plywood to fit between the joists on top of the batten fitted in step 6.

Step 8

Measure the shower drain base position on the floor and mark this onto the relevant piece of plywood. Using a jigsaw cut a hole in the plywood so that the shower drain base and shower drain socket will be exposed through the new floor.

Check the position of any pipes or wires and mark these on top of the joist for reference. Lay the plywood into position and pilot drill and countersink making sure you avoid any pipes and wires marked on the joists. Fix the plywood on top of the timber battens with a suitable wood screw at approximately 150mm intervals.

Please Note: the hole size should be no bigger than 180 x 180mm.

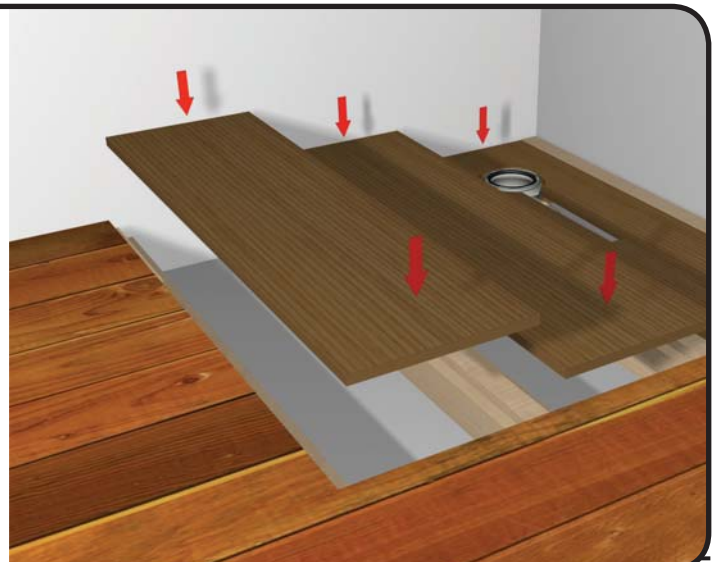

Step 9

Before proceeding, check thoroughly for pipes and wires.

If you are left with a gap between the edge of the shower tray and the start of the original flooring, this should be filled with a piece of the flooring that you removed in step 3 and securely screwed down onto the new plywood.

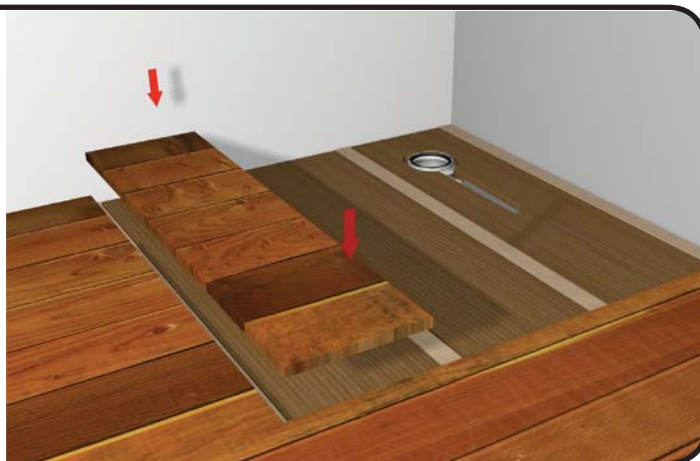

Step 10

Lay the shower tray into the required position to check the fit of the shower drain base. Once you are happy with the fit, carefully remove the shower tray (A) and store somewhere safe.

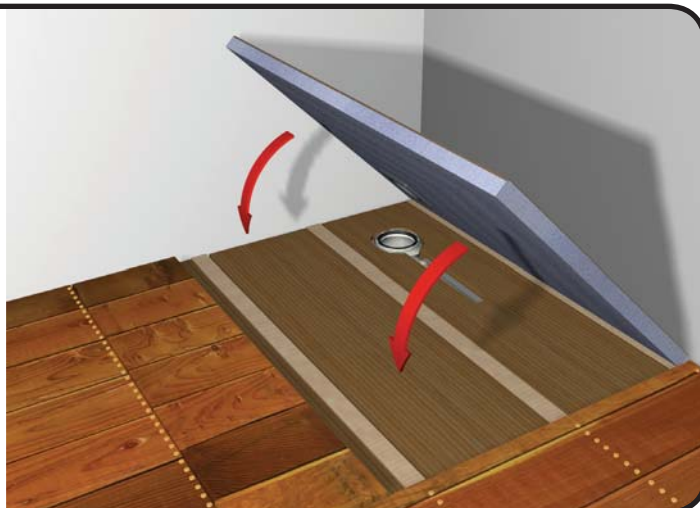

Step 11

Put on protective gloves and wear eye and breathing protection.

Paint the new plywood area with wood floor primer. When you have finished you can remove the protective gloves and eye and breathing protection.

Leave to dry for at least 2 hours.

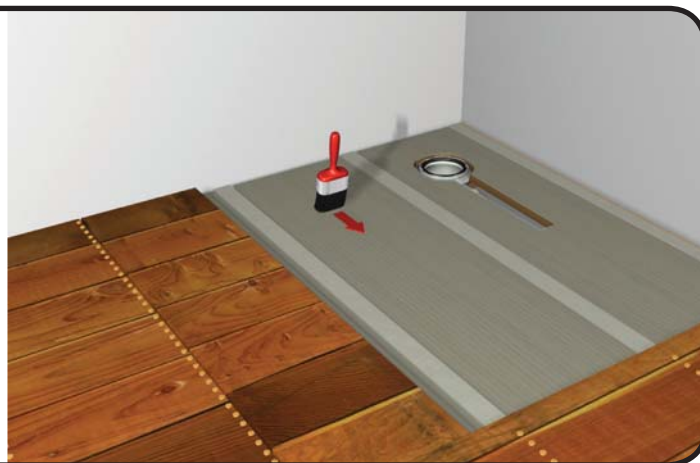

Step 12

Put on the protective gloves and wear eye and breathing protection.

Mix the cement based flexible tile adhesive in accordance with the adhesive manufacturer's guidelines in a clean bucket. Where the shower tray will sit, spread the adhesive onto the floor and drag a 4mm notched adhesive trowel across the surface. The notched adhesive trowel will make a ribbed pattern which will leave just the right amount of adhesive on the floor.

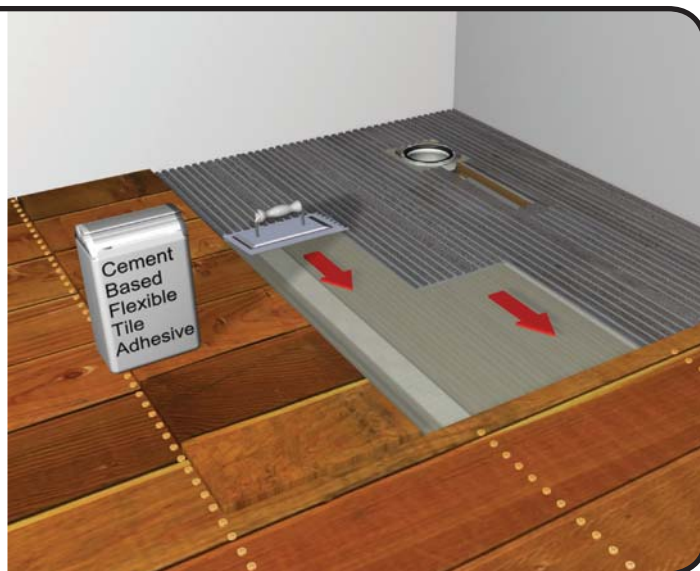

Step 13

Apply an even thick wavy line of Fix MD Adhesive across all four edges of the shower tray. Place the shower tray into position and bed down onto the adhesive. Check that the shower tray is level in both directions along the edge using a suitable level.

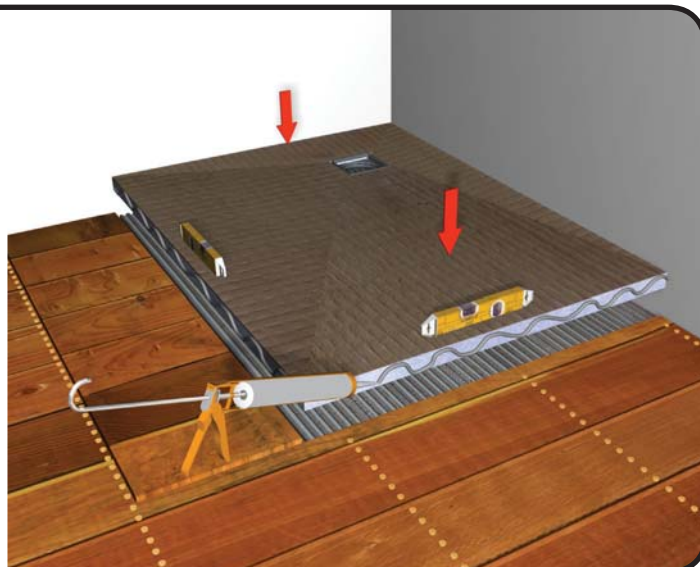

Step 14

Put your fingers through the drain hole in the shower tray. Push down on the shower tray and pull the shower drain base upwards until it clicks into place into the drain hole in the shower tray.



Step 15

Ease the shower drain internal bowl into the shower drain base. Ease the shower drain internal dome into the shower drain base.



Step 16

Lay and secure 10mm marine plywood board across the remainder of the bathroom ensuring that the finished area is level.

Alternatively, you may want to install 2440x600x10mm waterproof board in place of the marine plywood. This is much lighter, easier to cut and retains heat much better than plywood.

Note: The floor is designed to be fitted level, however water will sit on a flat surface so it is advisable to fit a suitable shower enclosure or screen to help contain the water and optionally, underfloor heating so that any water egress will quickly evaporate.

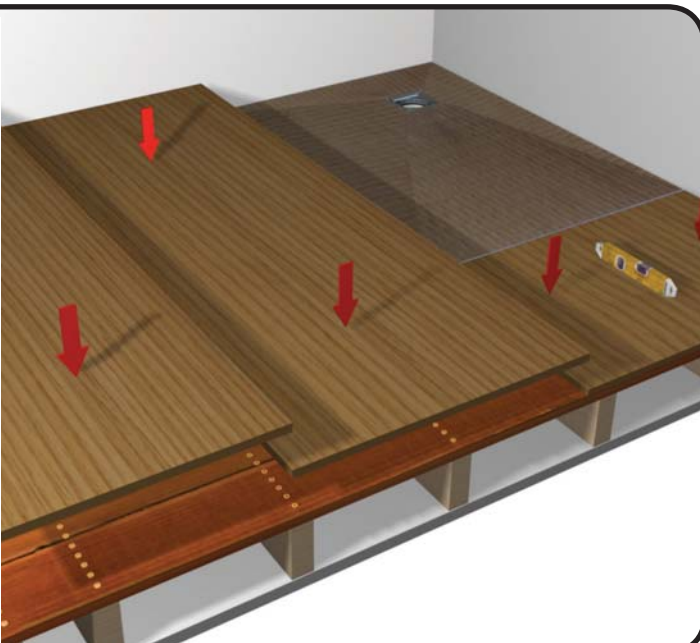

Step 17

Measure, cut with a safety blade then lay Waterproof Matting in strips to cover the remainder of the floor area around the shower tray allowing a 50mm overlap over the Waterproof Matting strips and 50mm up the edges of each wall. Also allow a 50mm overlap over the shower tray edges. Set the strips of Waterproof Matting to one side.

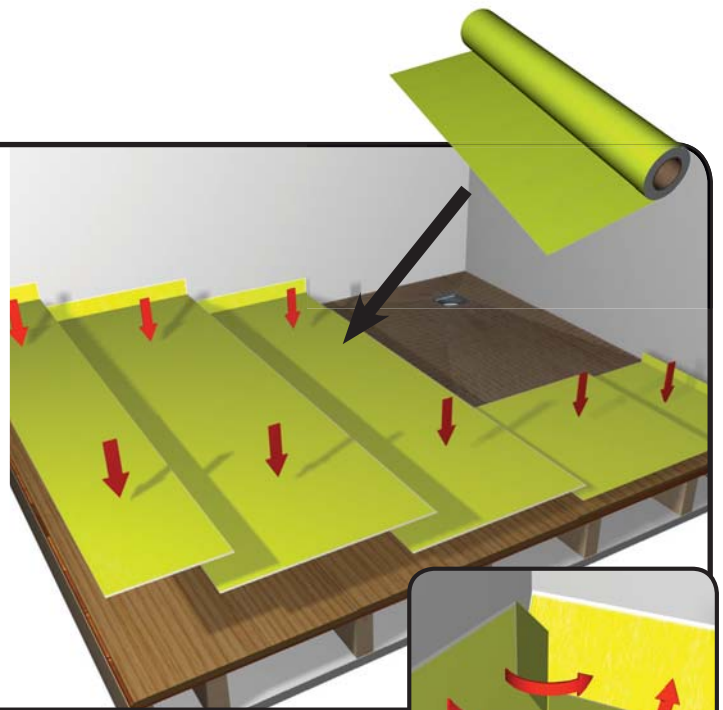

Step 18

Put on the protective gloves and wear eye and breathing protection. Mix the remainder of the cement based flexible tile adhesive in accordance with the adhesive manufacturer's guidelines in a clean bucket. Where the first strip of waterproof matting will lay, spread the adhesive across the surface and 50mm up the wall as appropriate. A notched adhesive trowel will make a ribbed pattern which will leave just the right amount of adhesive on the floor. Lay the strip of Waterproof Matting over the adhesive, ensuring no air bubbles are trapped between the adhesive and matting.

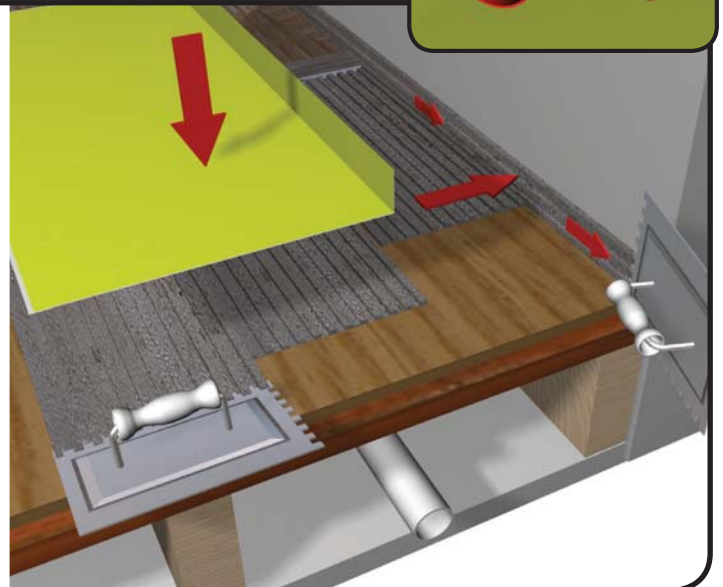

Step 19

Spread some adhesive across the floor surface and 50mm over the previously laid strip of Waterproof Matting. A notched adhesive trowel will make a ribbed pattern which will leave just the right amount of adhesive on the floor.

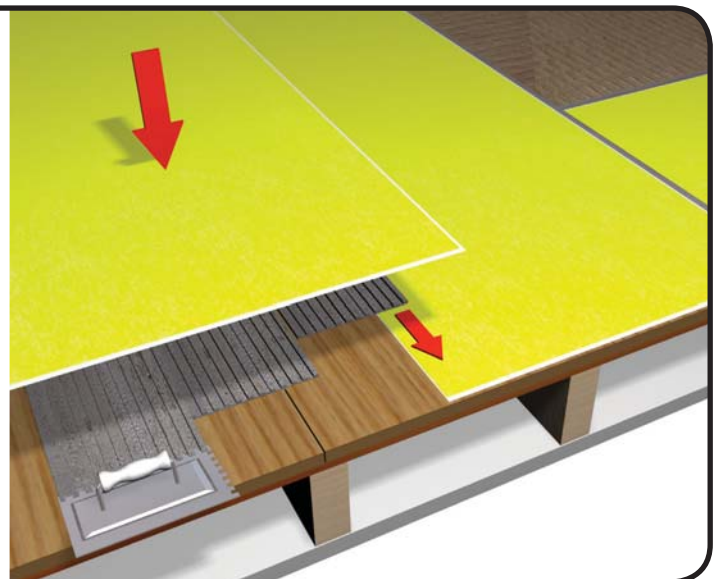

Step 20

Lay the next strip overlapping the last by 50mm and repeat Steps 19 & 20 ensuring that the adhesive and matting overlaps the walls, tray and each strip by 50mm to create a waterproof seal until the floor area around the tray is tanked out.

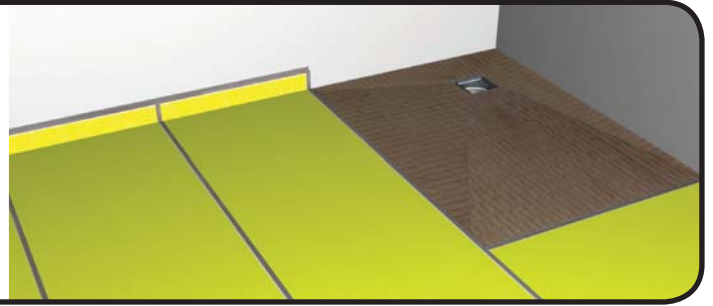

Step 21

Where the corner of the shower tray butts up against two walls temporarily place the Waterproofing Internal Corners into position and mark around them with a pencil. Depending on the size of the room and whether the remaining corners of the room already have a 50mm overlap up the wall you may only require 1 No. Waterproofing Internal Corner.

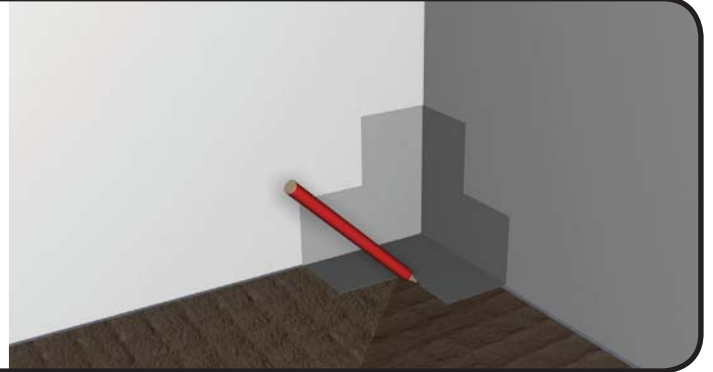

Step 22

Spread a thin layer of the pre-mix tape sealer slightly bigger than the pencil guide marked in Step 21, then push the Internal Corners firmly into the pre-mix tape sealer with the paintbrush. Apply a further thin layer of pre-mix tape sealer over the edges of the Internal Corners.

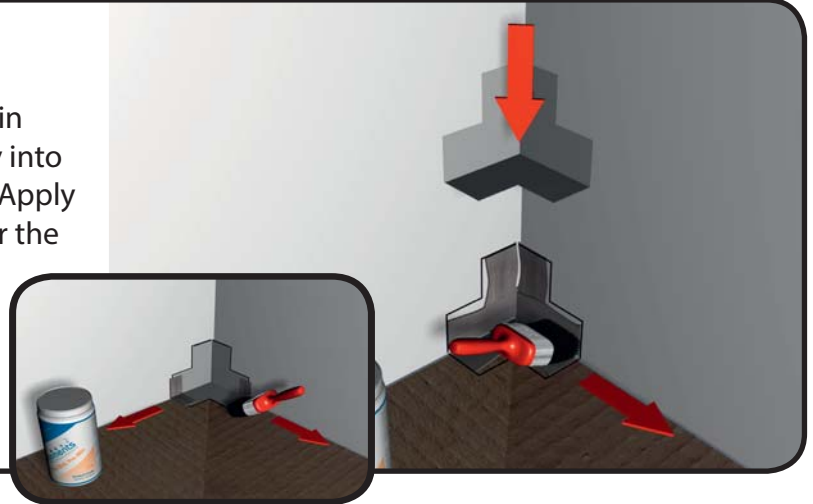

Step 23

Identify the edges of the shower tray that butt against a wall then measure and cut the Waterproofing Tape accordingly allowing a 20mm overlap over the Internal Corners. Apply a thin layer of pre-mix tape sealer approximately 120mm wide across the edge of the tray and the adjacent wall, then push the lengths of tape firmly into the pre-mix tape sealer.



IMPORTANT TILING ADVICE

IT IS ESSENTIAL THAT YOU DO NOT USE A READY MIXED TILE ADHESIVE. FLEXIBLE CEMENT BASED POWDERED ADHESIVE MUST BE USED.

The shower tray has slopes towards the drain pre-formed into the tray and these must be maintained when tiling.

If you use tiles that are larger than 100mm it is necessary to cut the tiles along the same lines as are pre-formed into the shower tray to maintain the slope. For best results and ease of installation we would recommend mosaics or tiles of 50mm to 100mm.

Perfect for use with electrical under tile heating due to its excellent thermal properties. It is however essential that you check with the manufacturer that their product is entirely suitable for the area that you intend to install it in. If you are installing under tile heating it is essential that you consider any areas that will need products fixed to the floor for example shower screens. Avoid installing under tile heating directly below any fixing point to avoid the risk of screwing through the heating.

Step 24

Place the disposable tiling aid into the shower drain hole on the shower tray. The tiling aid provides the edge that needs to be tiled up to whilst protecting the drain from debris.

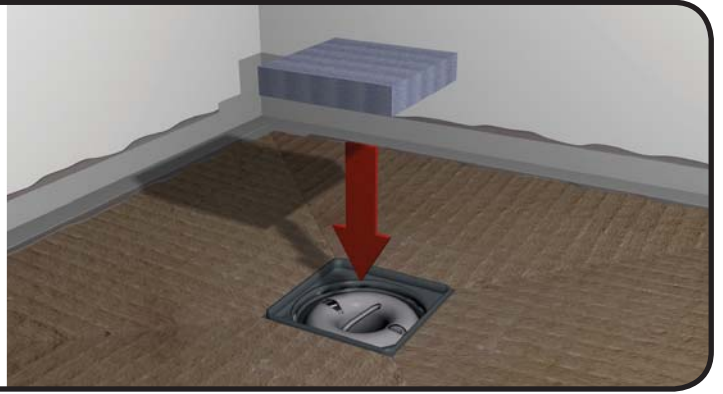

Step 25

After tiling the shower tray the shower drain top can be fitted. Gently place the shower drain top into the shower tray. Depending on your cutting skill, it may be necessary to file or sandpaper the cut edge to make it completely flat. Measure from the top of the finished tile to the top of the shower drain top.

From the opposite end/bottom of the shower drain top mark the same distance as previously measured.

Using a hard point saw, cut the excess from the bottom of the shower drain top.

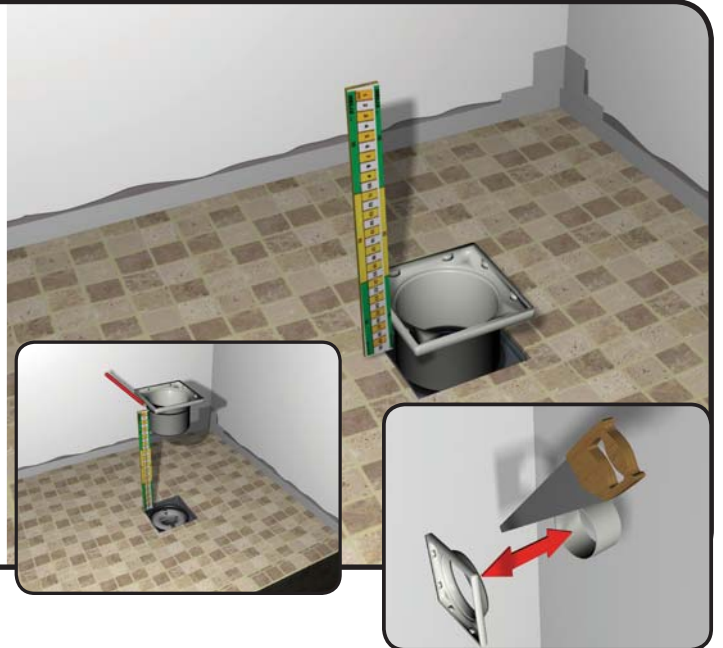

Step 26

Place a small blob of tile adhesive in the middle of all four sides of the shower drain hole in the shower tray. Gently ease the shower drain top into position in the shower tray.

Leave to set for approximately 3 to 5 hours



Step 27

Fill the gap between the edges of the shower drain top and the start of the tiles with the same grout used during tiling. Place the shower drain finishing grate into position. Leave to dry for at least 24 hours before using the shower.



Section C

Installation Type **C**

Fitting a shower tray and substrate element



Step 1

Note: Wear protective gloves, eye and breathing protection. Mix the 5kg bag of Fix-KST adhesive with approximately 1 Litre of water in a clean bucket which will give the adhesive a stiff consistency. Spread the Fix-KST adhesive onto the floor of the shower position and drag a 6mm notched adhesive trowel across the surface. The notched adhesive trowel will make a ribbed pattern which will leave just the right amount of adhesive on the floor.



Step 2

Place the Substrate Element into position and bed down onto the adhesive cement. Check that the Substrate Element is level in both directions using a suitable level.

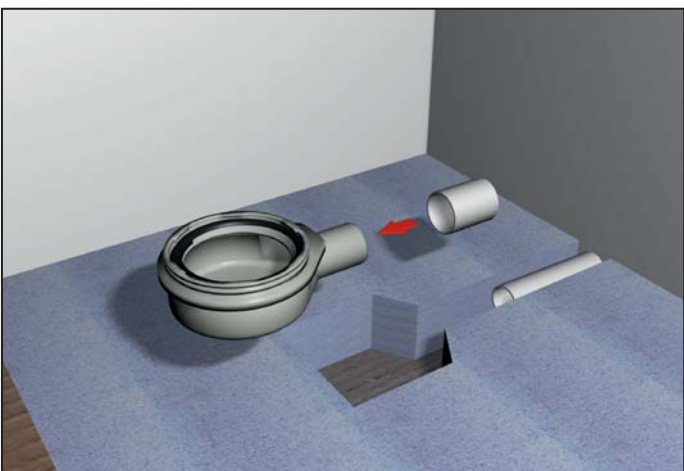

Step 3

For water to drain away properly, the wastepipe must have a fall of at least 3cm per metre. The wastepipe must be properly supported to hold its own weight and that of the Shower Drain. Connect the Shower Drain to your wastepipe using a 2" solvent weld connector. Once the solvent weld has set; pour water down the drain to check that the waste is not blocked and that there are no leaks.

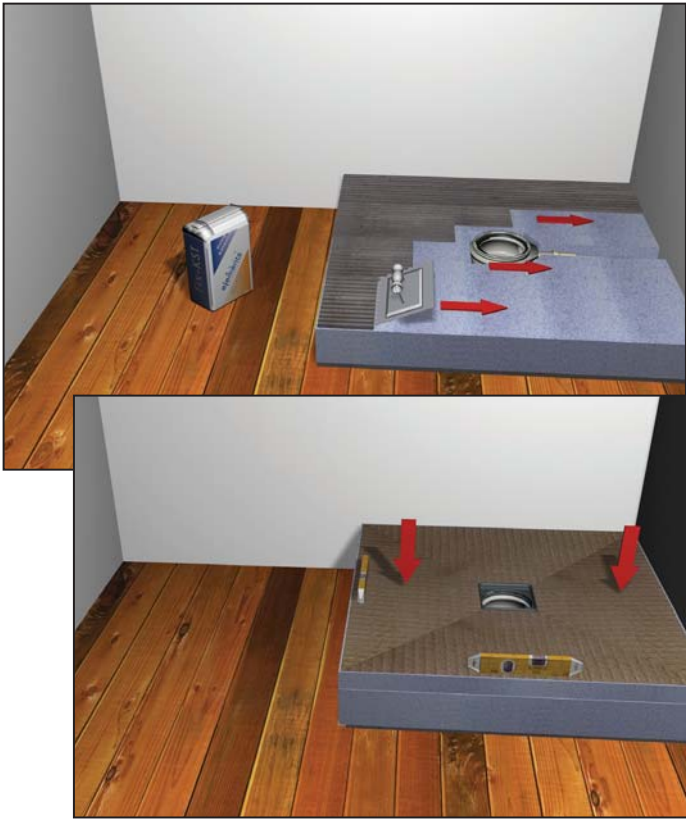

Step 4

Spread Fix-KST adhesive across the surface of the Substrate Element. Lower the Shower Tray onto the Substrate Element and push firmly into position. Check with a level that the edges of the Shower Tray are level in both directions.



Step 5

Put your fingers through the drain hole in the Shower Tray. Push down on the Shower Tray and pull the Shower Drain upwards until it clicks into place into the drain hole in the Shower Tray.



Step 6

Ease the Shower Drain Internal Bowl into the Shower Drain. Ease the Shower Drain Internal Dome into the Shower Drain. When you have finished you can remove the protective gloves and eye and breathing protection.



Step 7

You will need to tape all joints where the tray meets an adjoining wall/s. Cut lengths from the roll of Waterproofing Tape and set aside for the moment.

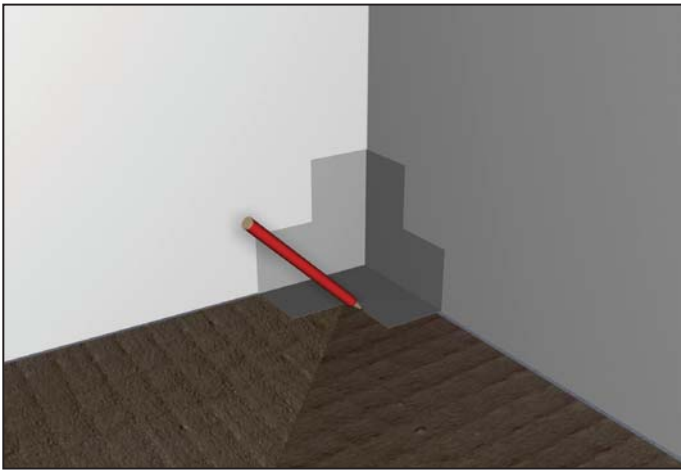

Step 8

Temporarily place the Waterproofing Internal Corners into position and mark around them with a pencil. Once you have marked they can be set aside for the moment. This is to show where you need to apply the Pro-SEAL tape sealer.

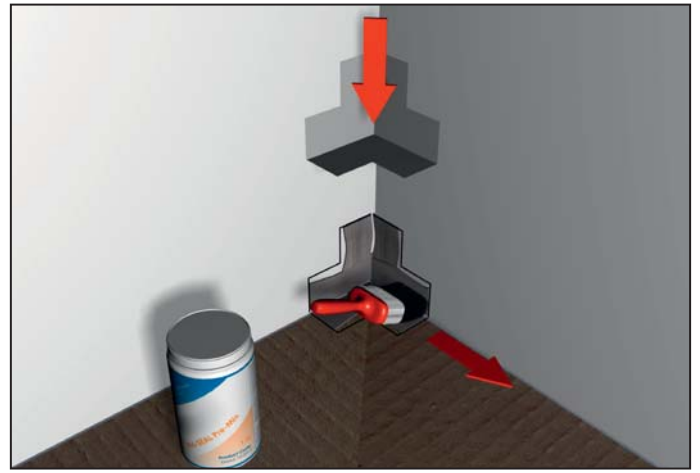

Step 9

Note: Wear protective gloves, eye and breathing protection.

Mix the 3.5kg Tub of Pro-SEAL tape sealer with 630ml of water in a clean bucket which will give the sealer a weak consistency. Using the unnotched end of the notched adhesive trowel, apply a thin layer of Pro-SEAL tape sealer to the internal corners of the shower area, slightly bigger than the pencil line marked in step 8.

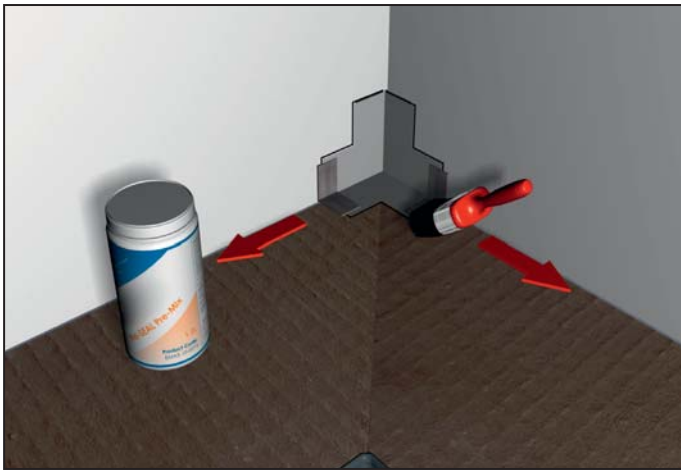

Step 10

Place the Waterproofing Internal Corners into the internal corners of the shower area and push firmly into the Pro-SEAL tape sealer. Apply a further thin layer of Pro-Dry tape sealer over the edges of the waterproofing internal corners.



Step 11

Where the shower area meets the wall apply a thin layer of Pro-SEAL tape sealer to the shower area and the adjoining wall approximately 60mm wide on both.



Step 12

Place the strips of Waterproofing Tape previously cut in step 7 along the edges of the shower area, folding half up the wall and half on the shower area as you go. Press firmly into the Pro-DRY tape sealer and the tape should also overlap the Waterproofing Internal Corners.

When you have finished you can remove the protective gloves (Q) and eye and breathing protection.

Leave to set for approximately 3 to 5 hours after which the tray is ready for tiling.

Important Tiling Advice

IT IS ESSENTIAL THAT YOU DO NOT USE A READY MIXED TILE ADHESIVE. FLEXIBLE CEMENT BASED POWDERED ADHESIVE MUST BE USED WITH SHOWER TRAYS.

The Shower Tray has slopes towards the drain pre-formed into the tray and these must be maintained. If you use tiles that are larger than 100mm it is necessary to cut the tiles along the same lines as are pre-formed into the Shower Tray to maintain the slope. For best results and ease of installation we would recommend mosaics or tiles of 50mm to 100mm.

Shower Trays are perfect for use with electrical under tile heating due to their excellent thermal properties. It is however essential that you check with the manufacturer that their product is entirely suitable for the area that you intend to install it in. If you are installing under tile heating it is essential that you consider any areas that will need products fixed to the floor for example shower screens. Avoid installing under tile heating directly below any fixing point to avoid the risk of screwing through the heating.

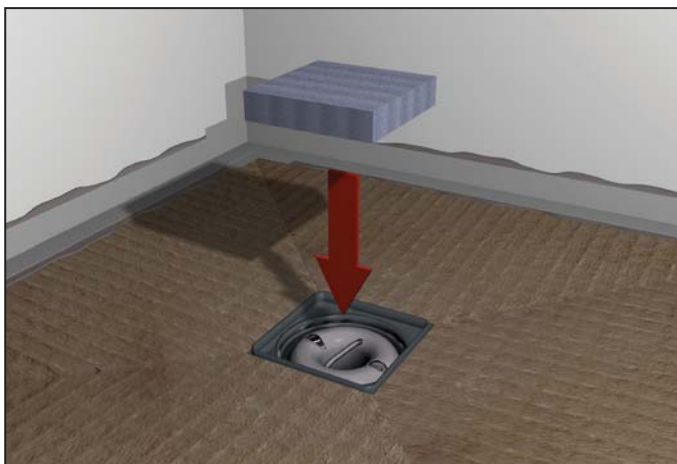

Step 13

Place the Disposable Tiling Aid (supplied with Shower Tray Install Kit or available to purchase separately) into the shower drain hole on the Shower Tray. The Tiling Aid provides the edge that needs to be tiled up to whilst protecting the Shower Drain from debris.

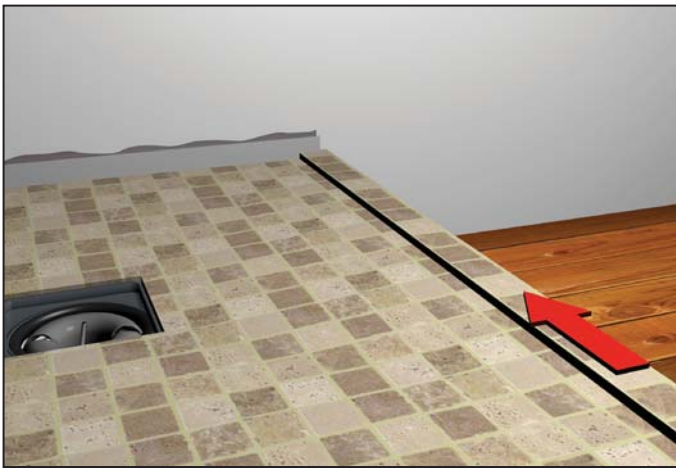

Step 14 (Optional)

After tiling the base of the shower area, we recommend that you add a further narrow border of tiles approximately 30mm to 40mm wide, along the top of the outside edge to act as a water retainer, stopping water running out of the shower area. The tiling aid can now be removed and disposed of.



Step 15

After tiling the Shower Tray, the Shower Drain Top can be fitted. Gently place the Shower Drain Top into the Shower Tray. Measure from the top of the finished tile to the top of the Shower Drain Top. From the opposite end/ bottom of the Shower Drain Top mark the same distance as previously measured. Using a hard point saw, cut the excess from the bottom of the Shower Drain Top. Depending on your cutting skill, it may be necessary to file or sandpaper the cut edge to make it completely flat.

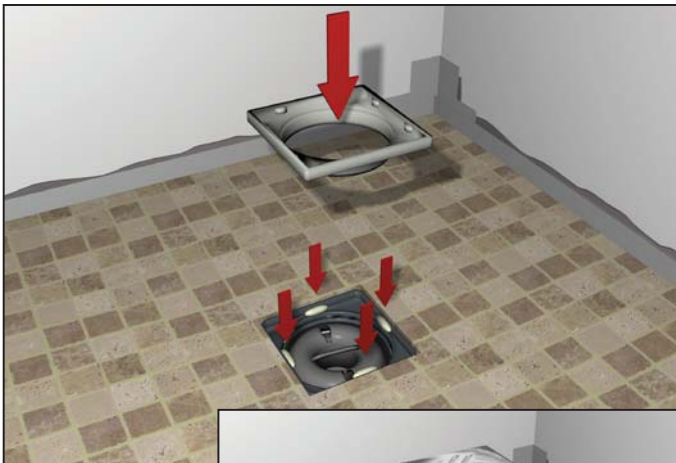

Step 16

Place a small blob of tile adhesive in the middle of all four sides of the Shower Drain Hole in the Shower Tray. Gently ease the Shower Drain Top into position in the Shower Tray. Leave to set for approximately 3 to 5 hours. Fill the gap between the edges of the Shower Drain Top and the start of the tiles with the same grout used during tiling. Place the Shower Drain Finishing Grate into position. Leave to dry for at least 24 hours before using the shower.