

PULSAR PLUS

Installation Guide

wallbox

INDEX

GETTING STARTED

Data Sheet	3
Safety Instructions	4
Package Contents	7
Before Installing	8
Prepare the Charger for Installation	8
Location	8
Positioning	8

INSTALLATION

NEMA Plug-in Installation	9
Existing NEMA Outlet	9
NEMA Outlet Installation	9
Placement	10
Installing the Wallplate	10
Mounting	11
Hardwire Installation	12
Determine Wiring Entry	12
Placement	12
Preparing your Charger	12
Removing the NEMA 14-50P Cable	14
Installing the Wallplate	14
Mounting the Charger	15
Electrical Wiring	15
Rated Current Adjustment	16
Closing the Charger	16
Holster	16

OPERATING

Powering on	17
Guide to LEDs	17
Registering your Charger	17
Compatibility	18
Charging	18
Troubleshooting	18

SERVICE	19
----------------	----

GETTING STARTED

Data Sheet

General Specifications

Model	Pulsar Plus
Cable length	25ft
Color	Matte Black
Charging protocol	SAE J1772
Dimensions	7.8" x 7.9" x 3.9" (without cable)
Weight	4.4lbs (without cable)
Operating temperature	-22°F to 104°F
Storage temperature	-40°F to 158°F
Electrical safety	UL 2594, UL 2231
EMC compliance	FCC Part 15 Class B

Electrical Specifications

Charging Power	9.6kW	11.5kW
Rated Current	40A	48A
Rated voltage AC ± 10%	208/240V (Level 2)	
Connector type	SAE J1772 Type 1	
Configurable current	from 6A to rated current	
Rated frequency	60Hz	
Enclosure protection rating	Type 4 per UL 50E	
Power input connection	plug connected (NEMA 14-50P) or hardwired	

Part Number Structure

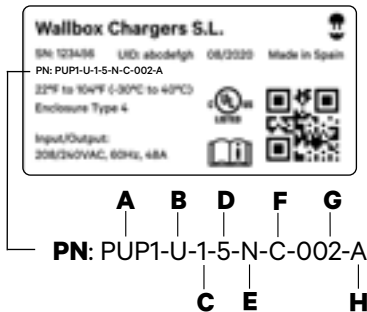

Code Definition

A Model	PUP1	Pulsar US Plus
B Cable	U	25ft
C EVC	1	Type 1
D Power	5	9.6kW
	6	11.5kW
E Power Input	O	Hardwired
	N	Plug-in Version
F Version	C	Hardwired + OCPP
	G	NEMA 14-50P + OCPP
G Custom	002	Black
H Revision	X	Revision X

GETTING STARTED

Safety Instructions

SAVE THESE INSTRUCTIONS | INSTRUCTIONS PERTAINING TO RISK OF FIRE OR ELECTRIC SHOCK

WARNING: When using electric products, basic precautions should always be followed, including those below. This manual contains important instructions that cover the safe installation, operation and maintenance of the unit.



- Read all instructions before installing and using your Wallbox charger.
- Permanent (hardwired) connection of your charger and/or installation of electrical circuits, conduit, and NEMA receptacles must only be performed by a qualified electrician in accordance with all local electrical codes and ordinances. Unauthorized installation or modifications will void the manufacturer's warranty.
- This device should be supervised when using around children.
- Do not put fingers into the electric vehicle connector.
- Do not use your Wallbox charger if the flexible power cord or EV cable is frayed, has broken insulation, or any other signs of damage.
- Do not use your Wallbox charger if the enclosure or the EV connector is broken, cracked, open, or shows any other indication of damage.
- Do not operate your Wallbox charger in temperatures outside its operating range of -22 °F to 122 °F (-30 °C to 40 °C).
- Do not open your charger in rain or other inclement weather.
- Do not open the front cover of your charger while it is connected to the power supply.
- Install your charger in a sufficiently ventilated location and avoid installation in areas with direct sunlight.
- Do not install your Wallbox charger near flammable, explosive, or combustible materials.
- All documents can also be found online at support.wallbox.com/na
- In case of flooding, do not operate your charger while it or your vehicle is submerged in water.
- If your charger was submerged in water due to flooding, have a qualified electrician inspect your charger prior to energizing or using your charger again.

Warning for Wallbox AC Plug-in Products: Grounding Instructions

Your Wallbox charger must be grounded. If it should malfunction or break down, grounding provides a path of least resistance for electric current to reduce the risk of electric shock. Your charger is equipped with a cord having an equipment grounding conductor and a grounding plug. The plug must be plugged into an appropriate receptacle that is properly installed and grounded in accordance with all local codes and ordinances.

WARNING: Improper connection of the equipment-grounding conductor may result in a risk of electric shock. Check with a qualified electrician or service person if you are in doubt as to whether the product is properly grounded. Do not modify the plug provided with the product. If it does not fit the receptacle, have a proper receptacle installed by a qualified electrician.



Warning for Wallbox Hardwired Products: Grounding Instructions

This product must be connected to a grounded, metal, permanent wiring system, or an equipment-grounding conductor must be run with the circuit conductors and connected to the equipment grounding terminal on the product.

See installation instructions.

WARNING: Consult a qualified electrician to ensure that the installation meets local regulations

Legal Notice

Any information in this manual may be changed without prior notice and does not represent any obligation on the part of the manufacturer.

Any resulting damage due to disregard or actions contrary to the instructions in this manual is excluded from the product warranty.

Images in this manual are for illustration purposes only and might differ from the delivered product.

Maintenance Instructions

- Your Wallbox charger contains no user serviceable parts. Do not attempt to repair or service any other part of the unit yourself. If the unit requires servicing, please contact Wallbox customer service.
- The installation, maintenance, and servicing of your Wallbox charger must only be performed by qualified personnel in accordance with applicable local regulations.
- Protect your Wallbox charger from any external impact.
- Take appropriate precautions with electronic medical implants.
- Disconnect the main service power to your charger before cleaning the unit. Do not use cleaning solvents to clean any part of your charger. Use a clean, dry cloth to remove accumulated dust and dirt.
- Under no circumstance should you over-tighten the connecting cable while it is connected to the vehicle.
- Ensure that the charging cable is positioned in such a way so that it will not be stepped on, tripped over, or subjected to damage or stress. Do not close your garage door on the charging cord.

Moving and Storage Instructions

- Your Wallbox charger should never be lifted or carried by the power supply cord or by the EV cable. Always lift or carry your charger by lifting up the charger's enclosure.
- The charger is only to be used for fixed installations and cannot be used as a portable device.
- Store your Wallbox charger in a dry location, and within the storage temperature of -40°F to 158°F (-40°C to 70°C)

FCC Note



This equipment has been tested and found to comply with the limits for a Class B digital device, pursuant to part 15 of the FCC Rules.

These limits are designed to provide reasonable protection against harmful interference in a residential installation.

This equipment generates, uses and can radiate radio frequency energy and, if not installed and used in accordance with the instructions, may cause harmful interference to radio communications. However, there is no guarantee that interference will not occur in a particular installation.

If this equipment does cause harmful interference to radio or television reception, which can be determined by turning the equipment off and on, the user is encouraged to try to correct the interference by one or more of the following measures:

- Reorient or relocate the receiving antenna of the affected radio or television.
- Increase the separation between the charger and any affected devices.
- Connect the charger to an outlet on a circuit different from the one to which any affected devices are connected.
- Consult the dealer or an experienced radio/TV technician for help.

Safety Icons



Caution



Sharp element,
risk of injurious
cuts



Risk of foot injury



Risk of electric
shock



Ground earth
connection
required



Flying debris,
risk of eye injury

GETTING STARTED

Package Contents

Components



Wallbox Pulsar Plus
with Charging Cable



Holster



Installation Guide



Amperage Reduction
Labels

Included Mounting Parts



ø6 x 45mm
Phillips Screws



ø5 x 40mm
Phillips Screws



ø8 x 40mm Wall
Anchors



Screw Plug
(Plug-in version)



T20 4 x 10mm
Torx Screws
(Hardwire version)



ø3.5 x 9.5 mm
Wallplate Screws

Required Tools

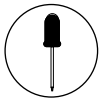

Small, flat
Screwdriver



Phillips Screwdriver
or Bit



Measuring
Tape



T20 Screwdriver
or Bit



Torque
Screwdriver
(Hardwire version)



Electric Drill
3/8" (8mm) bits



Stud
Detector



Spirit Level



Pencil



NEMA 14-50P 240V
outlet
Ground facing down
Or electrical material
to hardwire

GETTING STARTED

Before Installing Pulsar Plus

Before installing your charger, be sure to obtain any required permits and/or approvals in accordance with applicable codes, regulations, and ordinances for electrical installations.

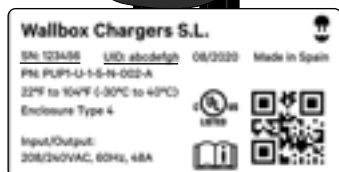

Prepare Charger for Installation

Before getting started, carefully lift the charger from the packaging, remove the cardboard covering the cables, and carefully unfasten the plastic cable ties on the EV cable bundle. Leave the cables in the box until needed to ensure they do not get damaged during installation.

Check the product label to identify the model/version of your charger. Make note of the serial number (SN) and unique identification number (UID) as you will need these to complete the registration of your charger.

Location

For the placement of your charger, consider how you will normally park your car, the location of the vehicle's charge port, and the length of the charging cable (25 feet/750cm).

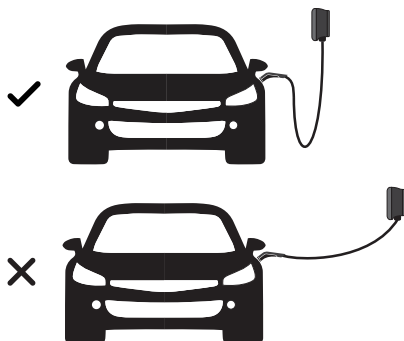

NOTE: You should always have enough slack in the charging cable so as not to apply tension to the cable or the cable connections.

For secure mounting, you will want to install your charger on a vertical wall stud or on a solid wall with appropriate mounting anchors.

Positioning

We recommend installing your charger as shown in the diagram on the left. Note that the minimum installation height must be at least 18" (46cm), measured from the bottom of your charger. Wallbox recommends an installation height of 50-67" (130-170cm).

With NEMA cable installations, be sure to take into consideration the 12" (30cm) length of NEMA cable when positioning your charger in relation to the NEMA receptacle.

For hardwire installations, the wiring may use either the rear or bottom access ports in your charger. Be sure to note that the power supply wiring and conduit (if used) will need to be placed on the left side of your charger.

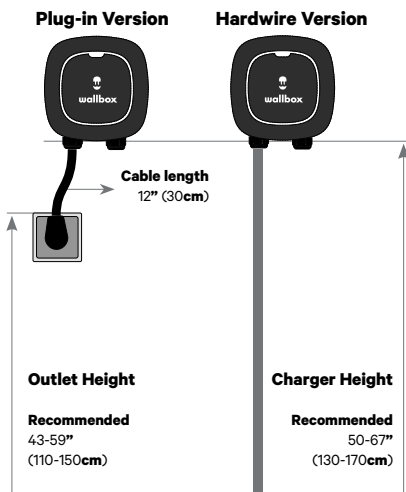

40A NEMA Plug-in installation: Page 9

40A or 48A Hardwire installation: Page 12

INSTALLATION

NEMA Plug-in Installation

Refer to one of the corresponding sub-sections below for an existing NEMA outlet or for installing a new NEMA outlet.

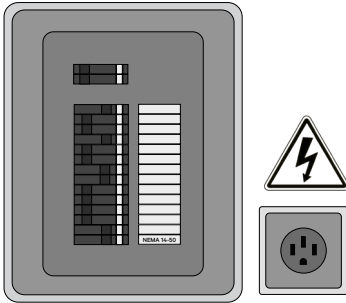

Existing NEMA outlet

If you already have a NEMA outlet, ensure that:

- It complies with local electrical codes.
- It has a designated circuit breaker and electrical wiring that are dimensioned appropriately.

Switch off the circuit breaker of the electrical outlet before installing your charger.



Instructions for electricians to install a NEMA outlet to be used with a Wallbox charger.

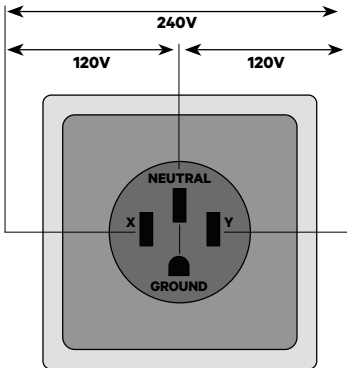

14-50R 240V/50A "RV" outlet



NEMA Outlet Installation

When installing a **NEMA 14-50** outlet, be sure the ground pin is facing down as shown in the diagram on the left.

Important Recommendations

- Ensure you have the correct permits for this electrical installation.
- Remember that the NEMA outlet must be placed on the left side of the charger as shown on Page 8.
- Keep in mind that the power supply cable length is limited to 12" (30cm).
- Ensure the electrical panel supports a 240V dedicated circuit with a new, dedicated two-pole circuit breaker.
- CAUTION: To reduce the risk of fire, connect only to a circuit with a branch circuit overcurrent protection of 50A in accordance with ANSI/NFPA 70 (US) C22.2 NO.280-13 (Canada).

INSTALLATION

NEMA Plug-in Installation

Ensure the NEMA receptacle is correctly installed before connecting your charger. See instructions on Page 9.

Follow our recommendations for location and positioning the charger in page 8

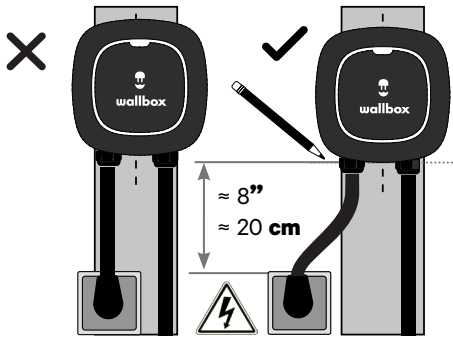
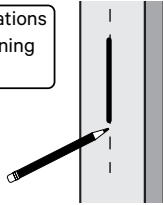

Make sure the outlet is powered off!

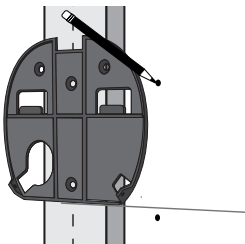
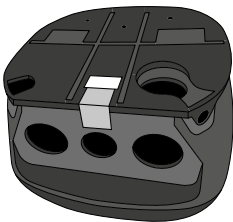

Placement

1. Using a wall stud finder, find the wall stud nearest to the NEMA outlet. Mark a vertical line approximately 20" (50cm) in length in line with the wall stud.

Alternately you may find a suitable location on a solid wall.

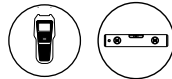

2. Ensure that the placement of the NEMA outlet and your charger will allow for an adequate connection of the 12" (30cm) NEMA cable.

3. Carefully lift the charger from the box, plug the NEMA cable into the outlet, and position the charger centered on the vertical line. Position the charger such that the NEMA cable has a gentle curve and is not stretched. Mark a horizontal line at the bottom of the charger.

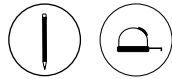

4. Unplug your charger and carefully place it back in the packaging box while you continue.

Installing the Wallplate

1. Remove the tape from the wall plate to detach it from the charger.

2. Place the wallplate with the bottom edge aligned with the horizontal line and the center holes aligned with the vertical line. Mark the location of the holes.



INSTALLATION

NEMA Plug-in Installation

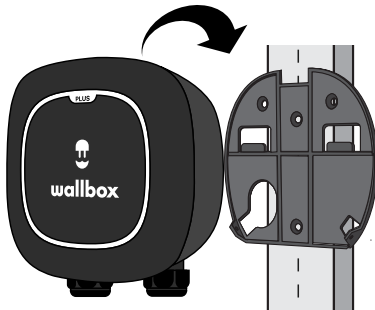
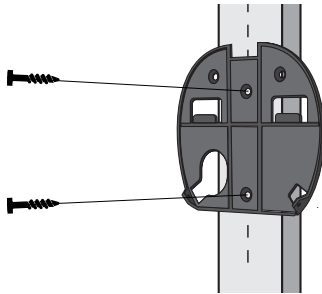
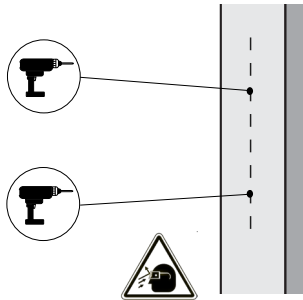

- 3.** Drill two holes with an appropriate sized bit. Place the wallplate in alignment with the holes



If you are mounting your charger on a solid wall, use the wall anchors provided with your charger



- 4.** Firmly mount the wallplate using the provided wall screws. Do not over-tighten the screws.



Mounting

- 1.** Carefully remove your charger from the packaging box and hang your charger from the top of the wallplate.
- 2.** Secure the charger to the wallplate using the provided wallplate screws. Do not over-tighten.

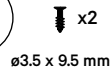

Proceed to the instructions for installing the holster and operating your charger, pages **16-17**

INSTALLATION

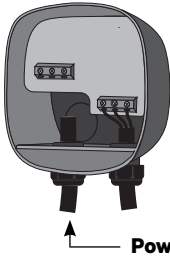
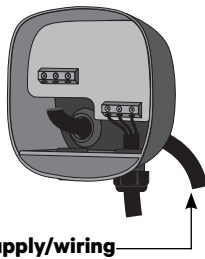
Hardwired Installation**Installation of your Wallbox charger with a permanent power supply****Bottom Connection****Rear Connection**

Power supply/wiring

Follow our recommendations for location and positioning the charger in page 8

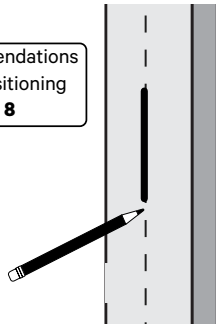

Make sure to power off any connections!

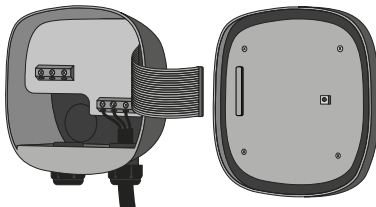
**Determine wiring entry**

Before hardwire installation, determine which entry port you will be using for your power supply wiring or conduit. Your charger can be connected from either the rear or bottom entry ports. Choose the most appropriate connection based on the placement of your wiring or conduit.

Be sure to note that the power supply entry for either port will be on the left side of your charger. Ensure that you locate your charger so that the power supply wiring or conduit is accessible on the left side of your charger.

Placement

Using a wall stud finder, find the wall stud nearest to and on the right side of the power supply wiring.

Mark a vertical line approximately 20" (50cm) in length in line with the wall stud at the approximate height of your mounting.

Alternately you may find a suitable location on a solid wall.

**Preparing your Charger**

Hardwire installation requires opening your charger to access and connect the hardwire power supply connection.

- Remove the cover frame from the front of your charger by removing the bottom screw that affixes the frame to the cover.
- Remove the four corner screws on the cover and carefully lift the cover.
- From the cover, carefully detach the ribbon cable. Set the cover aside.



T20
ø4 x 10mm



INSTALLATION

Hardwired Installation

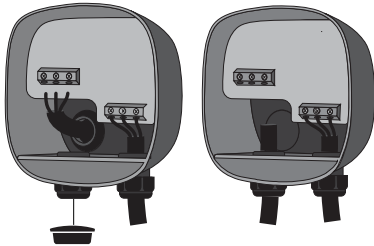
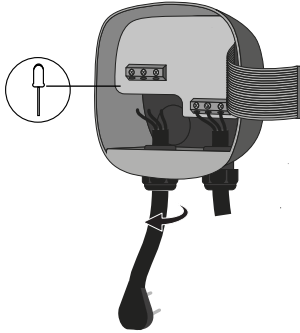

The rear/bottom aperture has a diameter of 1 1/4" (3.25 cm), therefore a 1" conduit fitting is recommended.

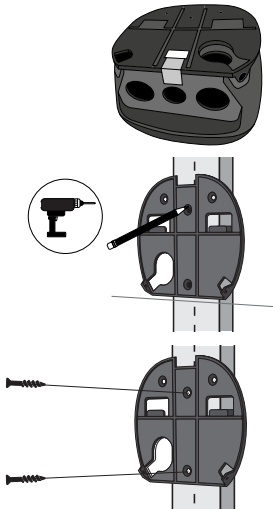

For **rear wiring installation**, draw the power supply wiring through the hole in the wall and then through the rear port of the wallplate before mounting the wallplate.

Removing the NEMA 14-50P cable

40A NEMA Model only

- To disconnect the NEMA power cable wiring, unscrew the terminal screws as shown in the diagram on the left.
- Loosen the left cable gland in a counter-clockwise direction and pull down on the NEMA cable to release it from your charger. Safely store or dispose of the NEMA cable.

For Rear wiring installations

Use a small screwdriver to cut a slit in the rubber grommet to create an opening for your power supply wiring. Alternately, if you are using conduit for the rear attachment, remove the grommet and attach the conduit fitting.

- For 40A model rear wiring installations, remove the bottom cable gland and attach the provided screw plug to cover the bottom port.

For Bottom wiring installations

Remove the attached cable gland (40A model) or screw plug (48A model) to allow the attachment of the conduit fitting.

Installing the Wallplate

- Remove the tape from the wall plate to detach it from the charger.
- Place the wallplate with the center holes aligned with the vertical line drawn earlier. Mark the location of the holes.

For **rear wiring installation**, also mark the location of the rear power entry port

- Drill two holes with an appropriate sized bit. Place the wallplate in alignment with the holes and firmly mount the wallplate using the provided wall screws. Do not over-tighten the screws.
 - If you are mounting your charger on a solid wall, use the wall anchors provided with your charger

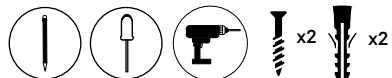

INSTALLATION

Hardwired Installation

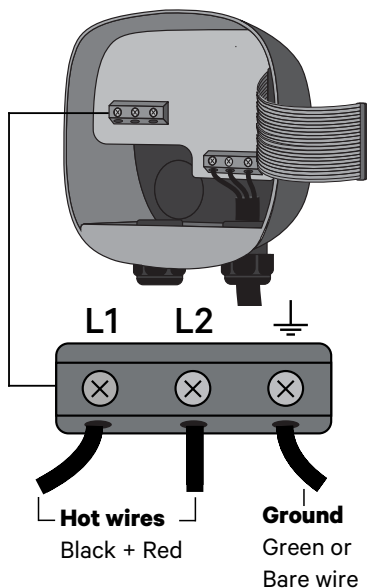
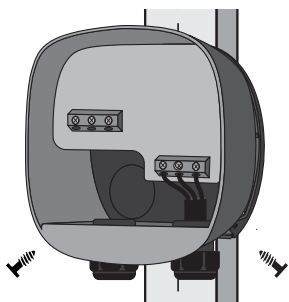
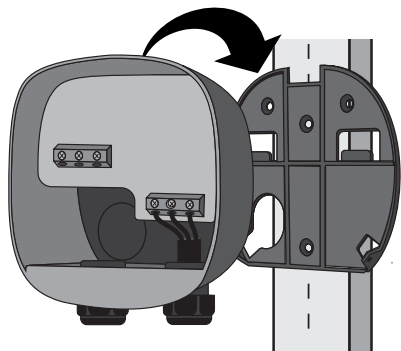

Mounting the Charger

1. Carefully remove your charger from the packaging box and hang it from the top of the wallplate.

For **rear wiring installation**, feed the power supply wires through the rear port (and through the rubber grommet, if not using conduit) with enough length to easily connect the wires to the terminals

2. Replace the two wallplate screws to secure your charger to the wallplate. Do not over-tighten



x2

ø3.5 x 9.5mm

Electrical Wiring

1. For **bottom wiring installation**, feed the power supply wires through the bottom port with enough length to easily connect the wires to the terminals.

NOTE: If using a conduit connection, pull the wiring through before connecting the conduit

2. Connect the electrical wires according to the diagram on the left.

Ensure the electrical panel supports a 208/240V dedicated circuit with a new, dedicated two-pole circuit breaker, rated for the selected amperage (see following section). The voltage between the hot wires (L1 and L2) must be 208/240V.

3. Use copper conductors only within the wire size range of 10 to 6 AWG (6mm² to 16mm²)
4. Strip 1/2" (12mm) of insulation off each wire, insert the wires per the diagram, and tighten each connector screw to 11.5in-lbs (1.3N·m)



INSTALLATION

Hardwired Installation

Rated Current Adjustment

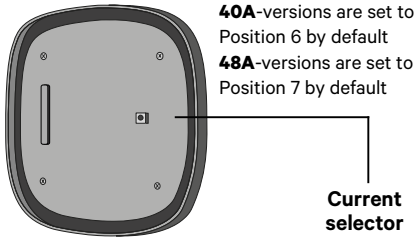
**Current selector**

Selecting a switch position exceeding the rated current will not exceed the rated current.

CAUTION To reduce the risk of fire, only connect your charger to a circuit with a branch circuit overcurrent protection of 125% of the selected max amperage setting of the device in accordance with ANSI/NFPA 70 (US) C22.2 NO 280 13 (Canada)

Hardwire Installations

2. On your charger cover, locate the current selector and set the rotary switch to the appropriate setting per the chart below.

Position	Amps	Circuit Breaker Rating
2	16A	20A
3	20A	25A
4	24A	30A
5	32A	40A
6	40A	50A
7	48A	60A

3. When setting your charger's current lower than the max. rating, use the label corresponding to your selected current value from the enclosed amperage reduction label sheet and affix it over the existing label on your charger.



Closing the Charger

1. Carefully reattach the communications cable to your charger cover and close the cover of your charger.

2. Insert the four corner screws to secure your charger cover. Do not over-tighten.

3. Making sure to properly align the bottom screw opening, place the cover frame on your charger and attach the frame with the screw. Do not over-tighten.



T
 ø T20
 5 x 10mm

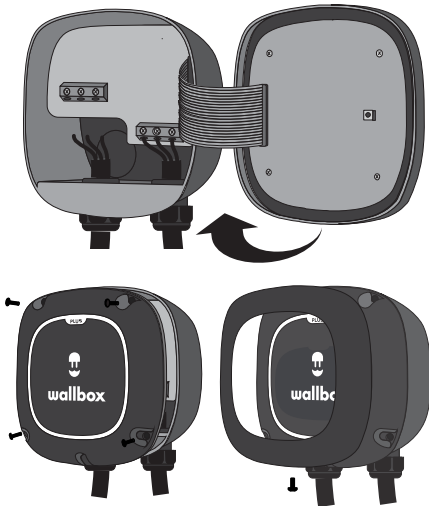

Torque: 13.3in·lbs (1.5N·m)

Proceed to the instructions for installing the holster and operating your charger, pages **16-17**

INSTALLATION

Holster

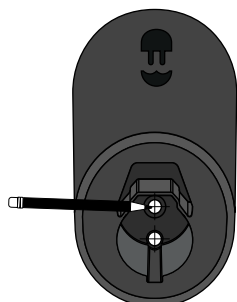

Installation Height

Outdoor:

18 - 48" (45 - 120cm)

Indoor:

24 - 48" (60 - 120cm)

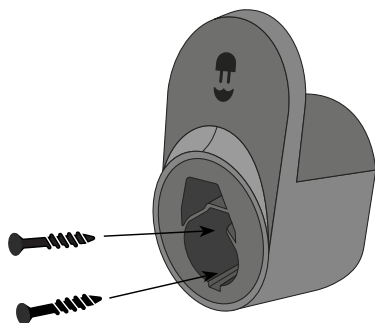

Installing the Holster

The holster is used to store your EV connector when not in use. You may place the holster wherever it is most convenient, being sure that the location does not place any tension on the charging cable.

1. For a secure mounting, locate the holster on a vertical wall stud or similar solid wall. Mark the two screw holes.



2. Drill two holes where marked with an appropriately sized drill bit, align the holster, and securely fasten the holster with the two provided screws. Do not over-tighten.



x2
ø5 x 40mm

3. Drape the charging cable around your charger and dock your EV connector in the holster.

- You may drape the charging cable on the holster, the charger, or both.

Proceed to the instructions for operating your charger in page **17**

Operating

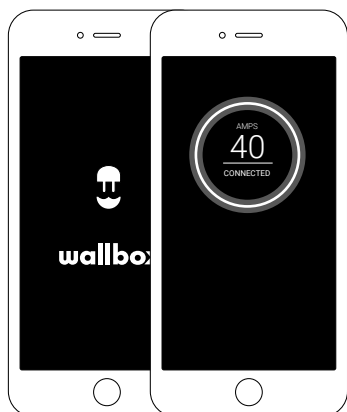
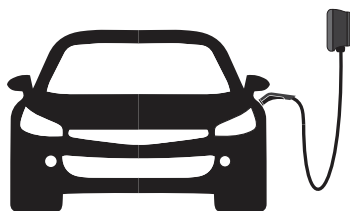

Compatibility

This Wallbox charger can be used with any Battery or Plug-In Hybrid Electric Vehicle (BEV/PHEV) that is compliant with SAE J1772 (Including Teslas using the Tesla provided adapter)

Charging

With your charger powered, connect the EV connector to your vehicle's charge port/input. Connecting your charger will automatically initiate the charging process.

If you are using the myWallbox app and have either locked your charger or set a charging schedule, the charging process will not start until you use myWallbox to unlock your charger or until the scheduled charging time.

Troubleshooting

If the LED halo is red (error notification), it means your charger has detected a safety issue with your electrical connection or vehicle.

Note that some errors will initiate an automatic reset after 15 seconds if the detected fault is resolved.

If the error does not automatically reset, unplug the EV connector from the vehicle and cycle through a power off/power on sequence by switching off the circuit at the circuit breaker and then switching it back on.

If the error persists, contact Wallbox customer service for additional instructions on how to resolve the error.

Service

Need more assistance? Contact Wallbox customer service:

(888) 787-5780

support.wallbox.com/na



support.wallbox.com/na

